



F-Line

F222
F260
F266

Professional
vacuum stuffers
for the
industry

F-Line F222/260/F266

Innovative conveyor technology

Rotary systems

Frey integrated a generously dimensioned vane cell pump with 16 chambers in the F-Line F222/260/266.

With the Peek-Cam-system a new material combination is used which concentrates the wearing out on only one part of the rotor system and ensures a higher service life. The rotor system works with highest portioning exactness and the new geometry of the chambers ensures an optimum sucking in of the filling material. The result is an optimum sausage aspect, also of critical sorts.

In connection with the most modern FREY- control and drive technology the rotor system of the F-LINE F222/260/266 achieves highest portioning exactness, also by producing high quantities. The maximum portioning speed is abt. 1.120 portions/minute.

The F-LINE 222 achieves a filling performance of max. 6.200 kg/h and a filling pressure up to 60 bar. The F-Line F222 is especially suitable for the production of sausages.

The F-Line F260 achieves a filling performance of max. 7.300 kg/h and a filling pressure up to 50 bar. The F-Line F266 with a maximum filling performance of max. 11.000 kg/h is conceived for the production of big calibers with highest filling performance.

F-LINE F222/260/266 manages to do portioning and linking of different types of casings such as natural and artificial casings, tins or as leading pump for attachments.



Flexibility

is a catchword in our time. The customers of today expect a larger product diversity that in former times. With F-LINE F222/260/266 you are well prepared for the future. The FREY vane cell pump guarantees an especially high care for the sausage meat. You can fill all kind of sausages - independent on the sausage meat - e.g. warm and liquid liver sausage, sausage with big meat pieces, tough raw sausage meat at minus degrees, you always get the highest quality of your products. An easy conversion to fill sausages with big meat pieces is always possible. On special request rotors with fewer wings and as result a larger volume of the chambers are available.

Clear advantages for F222/260/266 users

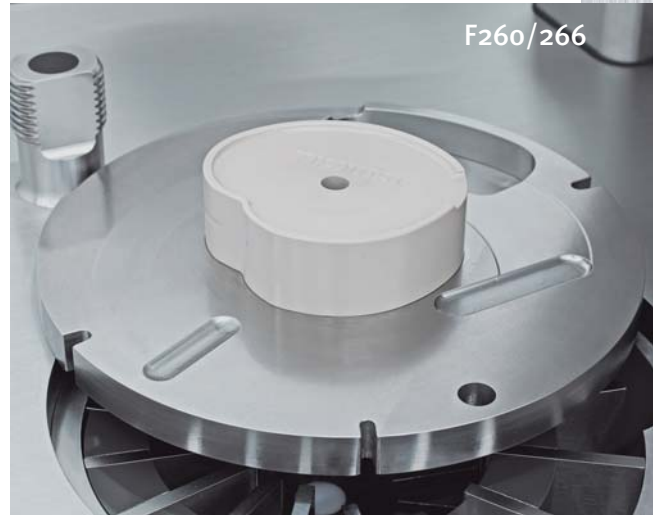

- ✓ Best product quality due to the large dimensions of the FREY meat pump.
- ✓ Highest hygienic standard, no screws or dirt corners in the direct food area.
- ✓ Excellent economic efficiency.
- ✓ High filling power.
- ✓ Low maintenance costs due to the maintenance-free servo drive.
- ✓ Fast and easy change of sorts.
- ✓ Low noise level due to the FREY servo drive.
- ✓ Low consumption of electricity due to the most modern control engineering.
- ✓ Easy cleaning of the vacuum system.
- ✓ Multiple combinations with C-LINE accessories and external devices.

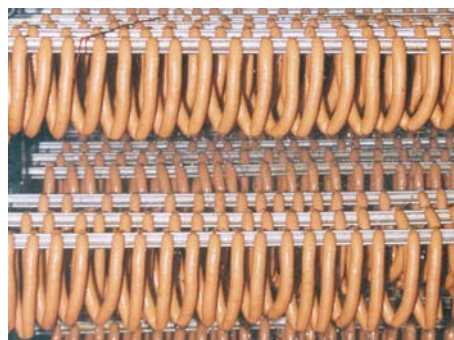

Drive technology of the future

Servo drive with positioning controller

The servo-drive with positioning controller is trend-setting. This drive unit makes an important higher positioning exactness possible, comparable to the old hydraulically driven systems. It is to be distinguished by a high moment of rotation and a quick reaction. The linking process is concipated extremely dynamically due to a correspondent programming of the drive parameters. Also with very high working speed the machine cares for the sausages during the linking process. So e.g. the acceleration of the rotor system during the start and stop process can individually be adjusted.

Dependent on the conveyor system the spiral stirrer is driven by a separate computer controlled FU drive. The rotating speed can be adjusted to the product and the filling speed.

Optionally a servo linking motor is available instead of the standard linking motor. The servo linking motor is distinguished by a higher dynamics and a more precise linking. The Servo linker is also used as drive of the grinding head system WK130.

The noise level of the machine is extremely low. Due to the high efficiency the F-Line needs about 30% less energy comparable with a hydraulic driven machine with the same performance. Considering the increasing energy prices a lower consumption of energy becomes more and more important.

This kind of drive unit is especially wear-resistant and maintenance-free as only few mechanical components are installed.

The servo positioning controllers are situated separately and thermally apart in the machine.

Simple and safe connection of all additional appliances at a strike guarded place. The digital drive and communication between the TC733 filler control and additional appliances with CAN-Bus system ensure processing security.



Convincing ergonomic details

Cleaning and hygiene

A simple cleaning is the basic requirement for best hygienic conditions in the production. Therefore FREY-stuffers have smooth external contours. F-Line F222/260/266 are conforming to the CE-regulations.

The splash and strike guard, which can be taken off, serves as additional protection to avoid damages made by the cleaning personal and pointed tools.

The machine housing is completely made of high-quality stainless steel.

The expenditure for cleaning and maintenance is very low due to the easy disassembling and neat countours between the parts.

Ergonomic operation

The operating zone has been arranged with a big operating comfort. The vacuum window is situated in the field of vision and in the working zone.

By activating a vacuum valve situated in the cover, the vacuum channel is automatically cleaned.

Linking gear

F-LINE is now equipped with a linking gear without limits for your production. It has especially been developed for the industry and has just proved itself. High-power toothed belts care for a maintenance-free operation. For filling big diameters, you can easily take off the linking gear by means of a quick-closing. Thereby, the way of the sausage meat is shortened and the greasing is minimized.

Special equipment

F-LINE F222/260/266 can flexibly be used, semi or fully automatic clipping machines can be adapted.

In connection with the conveyor linking system BASo2 and the automatic hanging line AHL02 the performance of the sausage production can enormously be increased.

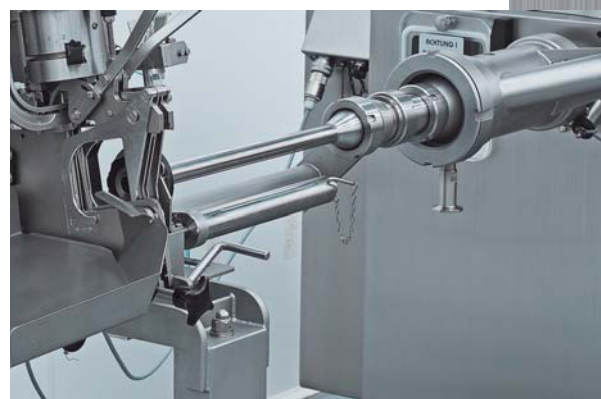

Powerful, practical and conforming to CE - standard

Target group of F-Line F260/F266:

- ✓ Industrial productions.
- ✓ Productions running fully automatic clipping machines.
- ✓ Production of big calibers.
- ✓ Productions running double outlets.
- ✓ Productions with attachments demanding high conveying capacity.
- ✓ Productions with high demands on the exactness of the portions and the quality.



Lifting device

F-LINE F222/260/266 can be delivered with or without a hydraulic lifting device for 200-liters-trolleys.

The stirring device, which is controlled by the transporting capacity and the meat guiding in the neck of the hopper ensure a continuous filling of the rotor chambers. A fast emptying of the machine as well as a quick change of sorts is guaranteed.

Hopper



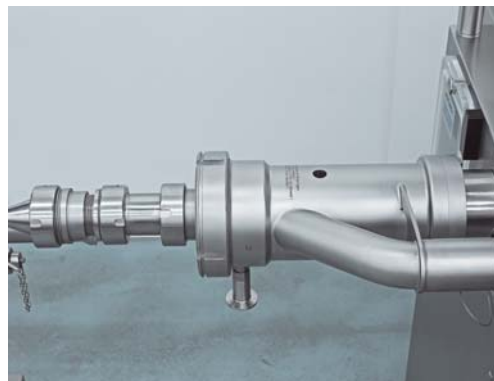

F-Line F260/266 is delivered with a 300-liters-hopper which is usually charged by means of a lifting and dumping device. For cleaning purposes the foot step can be tilted out. The hopper is damped by means of an integrated pressure spring. The contents of the hopper of F222 is 250 liters.

Target groups of F-Line F222:

- ✓ Medium-sized and industrial productions.
- ✓ Large production of sausages.
- ✓ Suitable for small calibrated products, which need a high filling pressure.
- ✓ In connection with BASo2 and AHL02 systems.
- ✓ Productions with high demands on the exactness of portions and the quality.
- ✓ Production of raw sausages with the grinding head system WK130.
- ✓ Optimal suitable for all FREY C-Line components. See the function survey below.



**Funktionsübersicht
Functions Survey**

															
		Kompakte 2-30 (also optional)	F-Line F50	F-Line F60	F-Line F100 / F103	F-Line F160 / F163	F-Line F190 / F193	F-Line F200	F-Line F222	F-Line F280	F-Line F286	KONTI C55	KONTI E80 / S200	K-Line KK500	
C-LINE	PM 40		ok	ok	ok	ok	ok	ok	ok	ok	ok	ok	ok	ok	
	PM 75		ok	ok	ok	ok	ok	ok	ok	ok	ok	ok	ok	ok	
	DMFB 90		ok	ok	ok	ok	ok	ok	ok	ok	ok	ok	ok	ok	
	CL 6		ok	ok	ok	ok	ok	ok	ok	ok	ok	ok	ok	ok	
	WK 130				SA	SA	SA	SA	SA	SA	SA				
	UTB 30/135	ok	ok	ok	ok	ok	ok	ok	ok	ok	ok	ok	ok	ok	
	SE 25			ok	ok	ok	ok	ok	ok	ok	ok	ok	ok	ok	
	PB 30/36			ok	ok	ok	ok	ok	ok	ok	ok		ok	ok	
	CLPS 300			ok	ok	ok	ok	ok	ok	ok	ok		ok	ok	
	FB 25/30	ok	ok	ok	ok	ok	ok	ok	ok	ok	ok	ok	ok	ok	
	FB 30/50	ok	ok	ok	ok	ok	ok	ok	ok	ok	ok	ok	ok	ok	
	PF 130	ok	ok	ok	ok	ok	ok	ok	ok	ok	ok	ok	ok	ok	
	BF 50/70/100	ok	ok	ok	ok	ok	ok	ok	ok	ok	ok	ok	ok	ok	
	FT			ok	ok	ok	ok	ok	ok	ok	ok		ok	ok	
	FTS			ok	ok	ok	ok	ok	ok	ok	ok		ok	ok	
	FTPS			ok	ok	ok	ok	ok	ok	ok	ok		ok	ok	
	DK 20 S			ok	ok	ok	ok	ok	ok	ok	ok	ok	ok	ok	
DK 20 F			ok	ok	ok	ok	ok	ok	ok	ok	ok	ok	ok		
DK 40			ok	ok	ok	ok	ok	ok	ok	ok	ok	ok	ok		
UFK		ok	ok	ok	ok	ok	ok	ok	ok	ok	ok	ok	ok		

IPC control TC 733 with touch screen operation

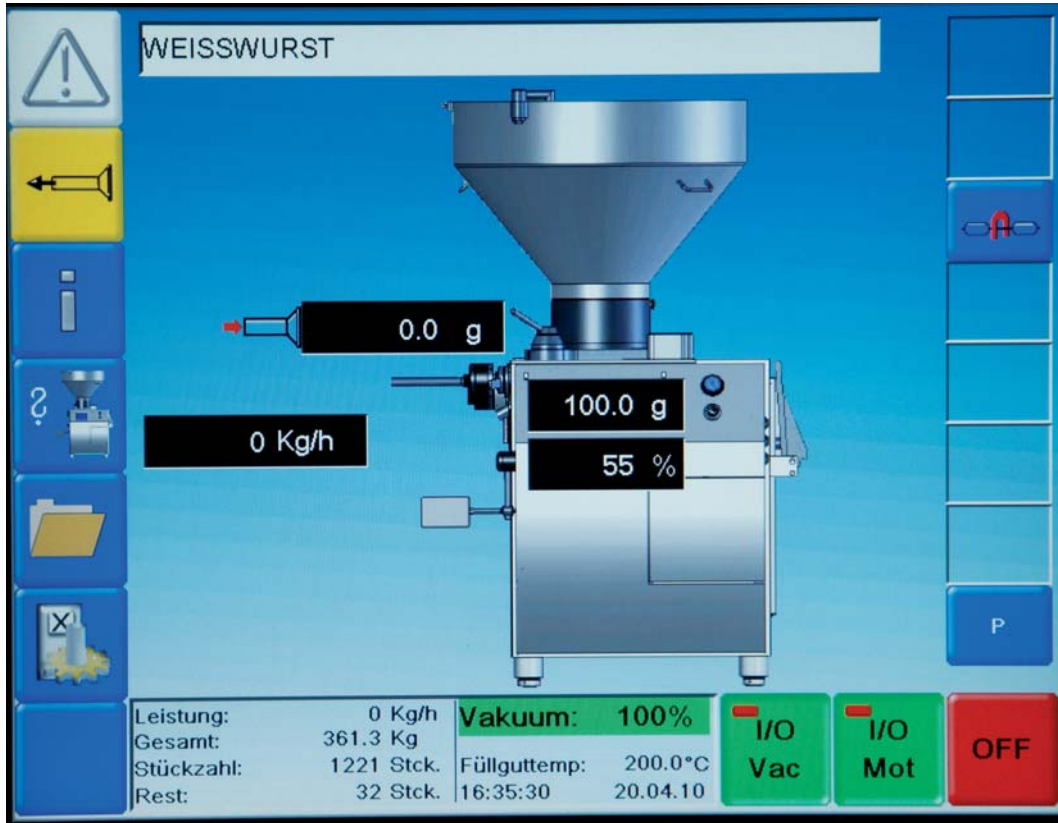

The ultimate stuffer control system with all variety of functions consists of an industrial personal computer and a touch screen panel in the front door of the filling machine.

- solid hardware
- industrial PC with 266 MHz and an ergonomic 8,4" touch screen panel
- interfaces: CF Card, USB, Ethernet 10/100 Mbps
- online connection with your office PC via TCP/IP network connectivity
- powerful software without limits
- logbook for the filling process and errors
- F-Line in connection with TC733 meet the BDE standard of WS Food.

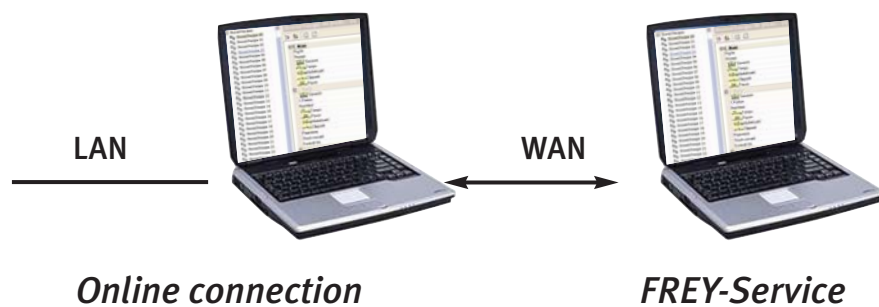

TC 733 offers an inimitable variety of functions.

Survey of functions:

- **Weight input**
can be chosen between 0,1 and 100.000 g.
(from 0,0 - 999,9 g in 0,1 g steps)
- **Number of links** from 0 - 9,9 turns
- **Clipping time**
- **Preselection of pauses** for portioning and linking
- **Normal and continuous operation**
- **Filling programs with table of contents**
- **Programs for cooked sausages**
- **Service- and maintenance programs**
- **Diagnosis programs**
- **Counter of quantity and pieces, pre-selection of pieces**
- **Twist delay / twist advance of the linker**
- **1 st portion makeweight**
- **Speed control**
infinitely adjustable also during the filling process
- **Digital vacuum control**
optionally available is an electronic control valve for the stop of the machine and an automatic cleaning of the vacuum pump.
- **Automatic pressure regulation and torque control**
- **Electric pulse control for automatic clipping machines**
- **Relieve/sucking back mechanism**
- **Activation of CL- and CLPS- line**
- **Control of the Pattyformer PF130**
- **Different languages adjustable**
- **Different backgrounds adjustable**
- **Program administration with protection**
- **Software update per USB - stick**
- **Interfaces: USB, Ethernet**
10/100 Mbps
- **Online connection with your office PC via TCP/IP connectivity**
- **Visualizing of filling and linking process**
- **Logbuch of the filling process and errors**

Interface/connection

The filling machines will be integrated in your computer network. By this way you control your filling machines from your office. The connection is done over the Freeware Software VNC which offers a full functional diversity per telecontrol. You can do all settings on the machines from your office. Load or store filling programs. The starting and stopping function of the machine can only be activated via the operating bar.

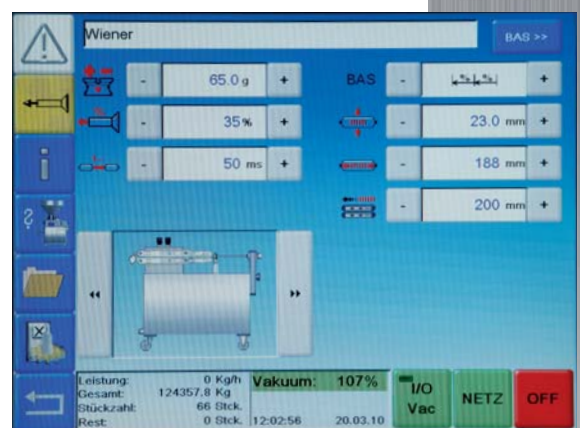



DHGN2 + DA2002

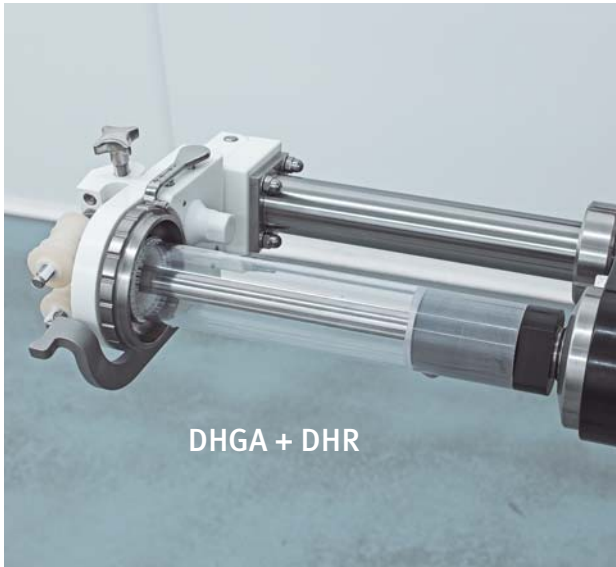

DHGA + DHR

Casing holder devices

DHGN2

Casing holder devices are available as accessory for FREY-vacuum stuffers. They make the filling process faster and easier. The casing holder DHGN2 is especially designed for natural casings.

DHGA

Compared with the DHGN2 the DHGA is additionally equipped with a ceramic bearing with support for the casing holder tube (DHR) and the roller kit (ROKI). The casing holder device can also be used for collagene and cellulose casings. The DHGA ensures a continuous advance of the casing during the linking process.

The DHGN2 and DHGA are maintenance-free because no drive is necessary.

With the help of our casing holder devices you always get tight and solid sausages at maximum filling speed. Extra skilled staff is not needed, also unskilled persons can work at the filling station. The casing holder device is easy to assemble and can be tilted upwards together with the linking gear. The casing holder device can easily be mounted and with the linking gearbox the device can be swivelled to side. The casing tension is infinitely adjustable.

Furthermore, we offer pneumatic casing spoolers (DA2002). They save time to increase the productivity of the filling station.

Services

are nowadays more and more important.

The reliability of our demonstrators and technicians stands for the high quality of FREY products.

Our stuffers are well-thought out even in the smallest details. They are well-known for their long service life

Our trained staff gives you also advice by telephone, fax or email in order to help you immediately.





Technical data:

	F-Line F222	F-Line F260	F-Line F266
Capacity of the filling hopper:	250 liters	300 liters	300 liters
Maximum filling performance:	6.200 kg/h	7.300 kg/h	11.000 kg/h
Filling pressure up to max:	60 bar	50 bar	45 bar
Capacity of the chambers:	76 g	102 g	102 g
Number of wings:	16	16	16
Portioning range:	5-100.000 g	5-100.000 g	5-100.000 g
Voltage / Tension:	400V/50Hz	400V/50Hz	400V/50Hz
Rotor system drive:	Servo	Servo	Servo
Stirrer drive:	FU	FU	FU
Control type:	TC 733	TC 733	TC 733
WS Food standard interface:	serial	serial	serial
Total connected load max:	15,5 KW	15,5 Kw	16,5 Kw
Suction power of the vacuum pump:	21 cbm/h	21 cbm/h	21 cbm/h
Machine weight (net)*:	1.020 kg	1.120 kg	1.200 kg
Portioning speed max:	1.000 port/min.	1.120 port/min.	1.120 port/min.

Servo drive of the linker optionally available (necessary for WK130)
 Special voltage on request (increase of weight upto 80 kg).
 Optionally available: electronic control valve for the vacuum system

Technical modifications are subject to change.

Accessories:

- Rotor extractor
- Outlet cleaner
- Operating instructions
- Counter screw
- Accessories holder

Filling tubes

Flange 73:	Flange 35:
12/24/30/42 mm	14/20 mm
12/24/30/42 mm	14/20 mm

Special accessories

In order to come up to your product diversity, you can receive special filling tubes or other additional equipment from us, individually made for you.

On the Frey accessories trolley all accessories find their place.

We would be pleased to inform you.
 Please call or write us.



F-Line F222/F260/F266

Dimensions

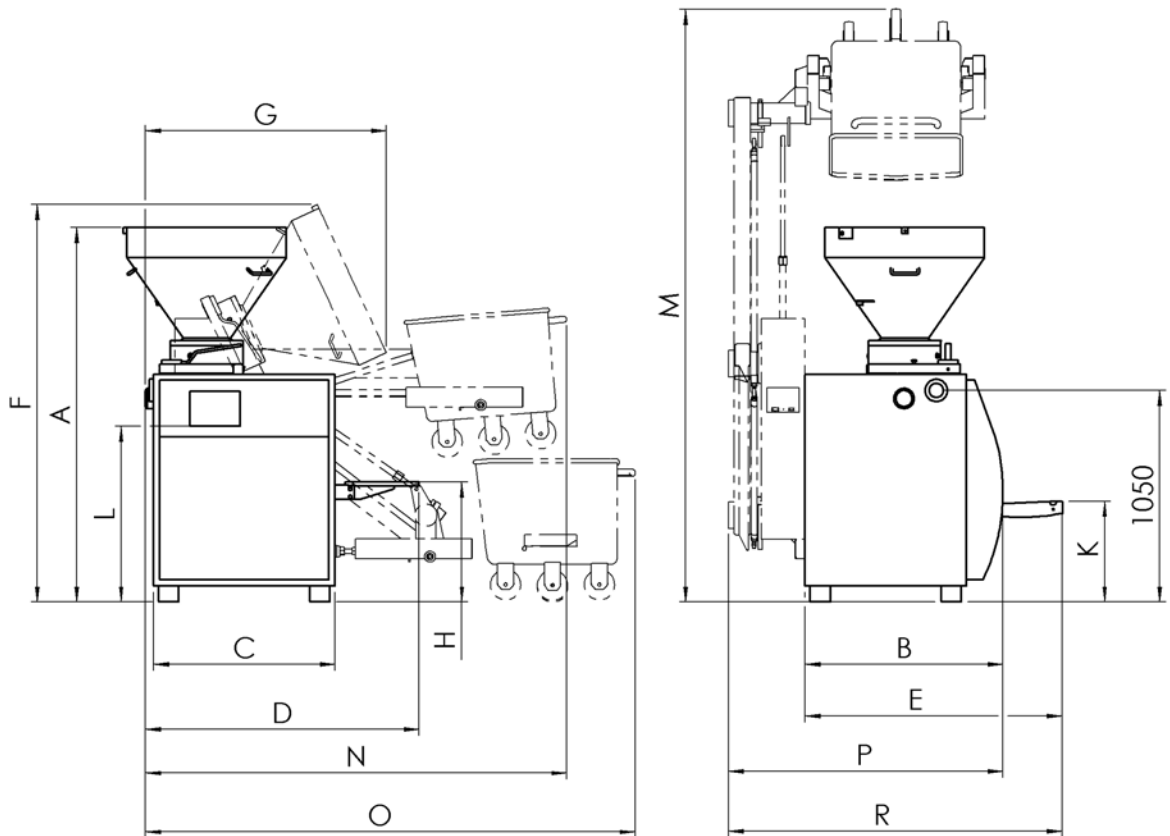

Maß	F222	F260	F266
A	1950	1970	1970
B	950	950	950
C	900	900	900
D	1360	1360	1360
E	1250	1250	1250
F	2100	2100	2100
G	1410	1460	1460
H	790	790	790
K	400	400	400
L	860	860	860
M	2950	2950	2950
N	2090	2090	2090
O	2430	2430	2430
P	1330	1340	1340
R	1630	1640	1640



Heinrich Frey
 Maschinenbau GmbH
 Fischerstr. 20
 D-89542 Herbrechtingen
 Germany
 Phone: +49 7324 172 0
 Fax: +49 7324 172 44
 Internet: www.frey-maschinenbau.de
 Email: info@frey-maschinenbau.de